

Relational Database Design: E/R-Relational Translation

Introduction to Databases

CompSci 316 Fall 2016



DUKE
COMPUTER SCIENCE

Announcements (Tue. Sep. 13)

- Homework #1 due in one week
 - Please please please start early
- Project description available soon

Database design steps: review

- Understand the real-world domain being modeled
- Specify it using a database design model (e.g., E/R)
- Translate specification to the data model of DBMS (e.g., relational)
- Create DBMS schema

☞ Next: translating E/R design to relational schema

E/R model: review

- Entity sets
 - Keys
 - Weak entity sets
- Relationship sets
 - Attributes on relationships
 - Multiplicity
 - Roles
 - Binary versus n -ary relationships
 - Modeling n -ary relationships with weak entity sets and binary relationships
 - ISA relationships

Translating entity sets

- An entity set translates directly to a table
 - Attributes → columns
 - Key attributes → key columns

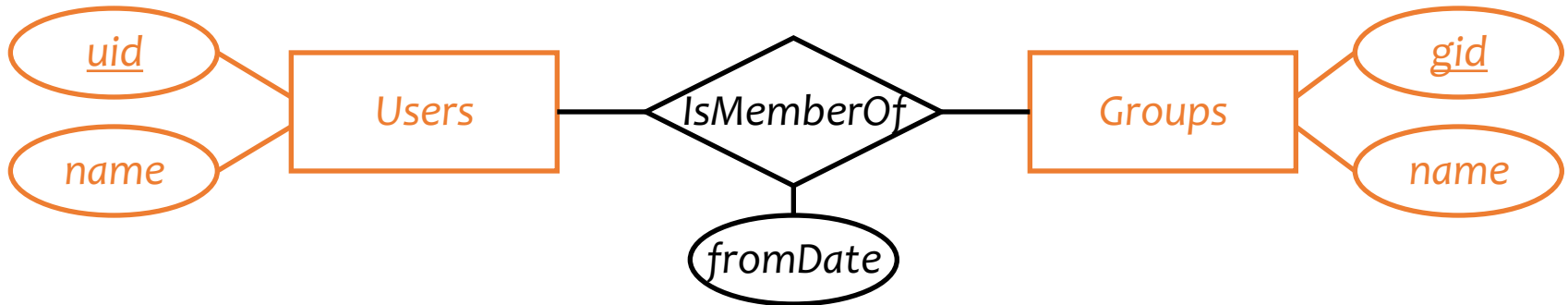

User (uid, name)

Group (gid, name)

Translating weak entity sets

- Remember the “borrowed” key attributes
- Watch out for attribute name conflicts

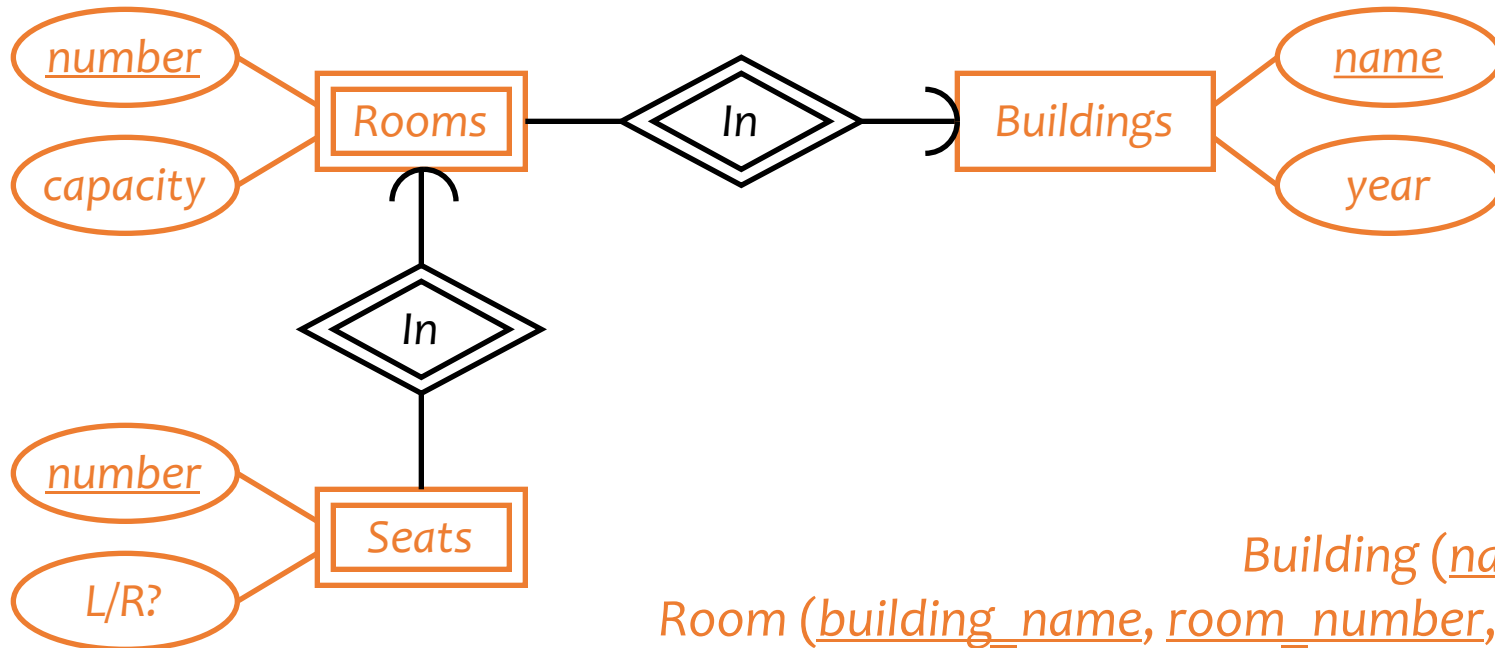

Building (name, year)

Room (building_name, room_number, capacity)

Seat (building_name, room_number, seat_number, left_or_right)

Translating relationship sets

- A relationship set translates to a table
 - Keys of connected entity sets → columns
 - Attributes of the relationship set (if any) → columns
 - Multiplicity of the relationship set determines the key of the table

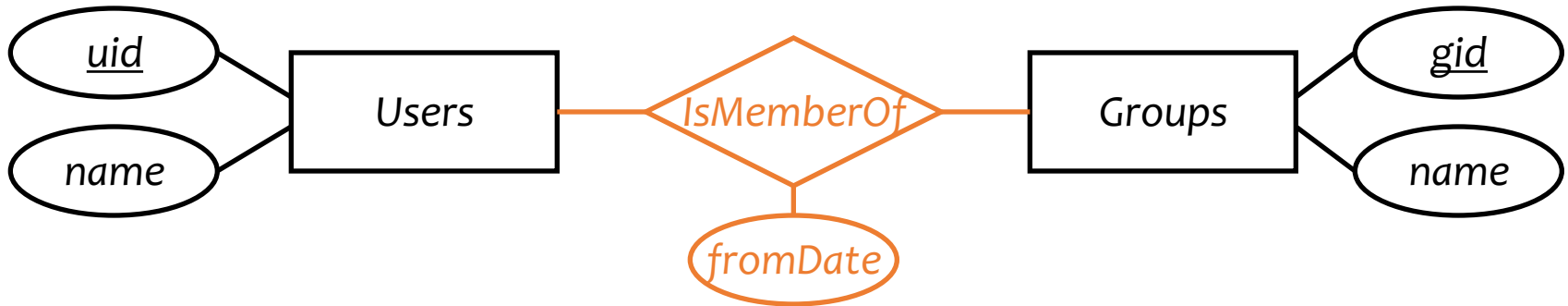

Member (uid, gid, fromDate)

More examples

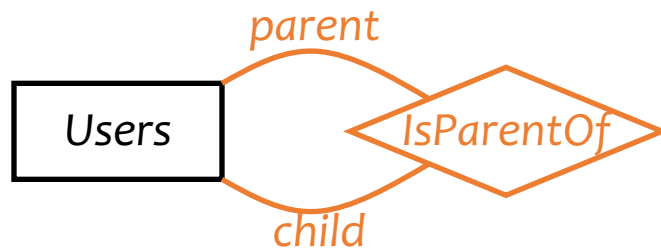

Parent (parent_uid, child_uid)

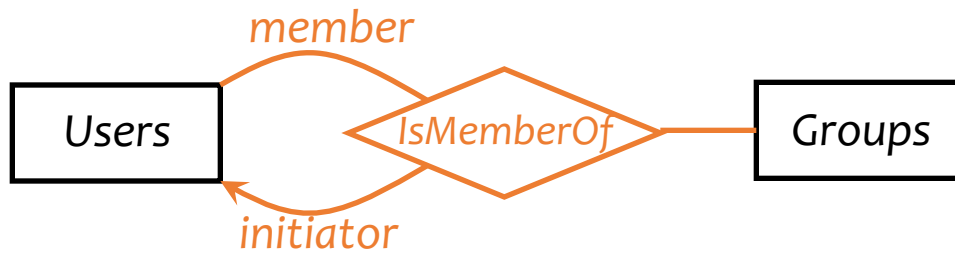

Member (uid, initiator_uid, gid)

Translating double diamonds?

- Recall that a double-diamond (supporting) relationship set connects a weak entity set to another entity set
- No need to translate because the relationship is implicit in the weak entity set's translation

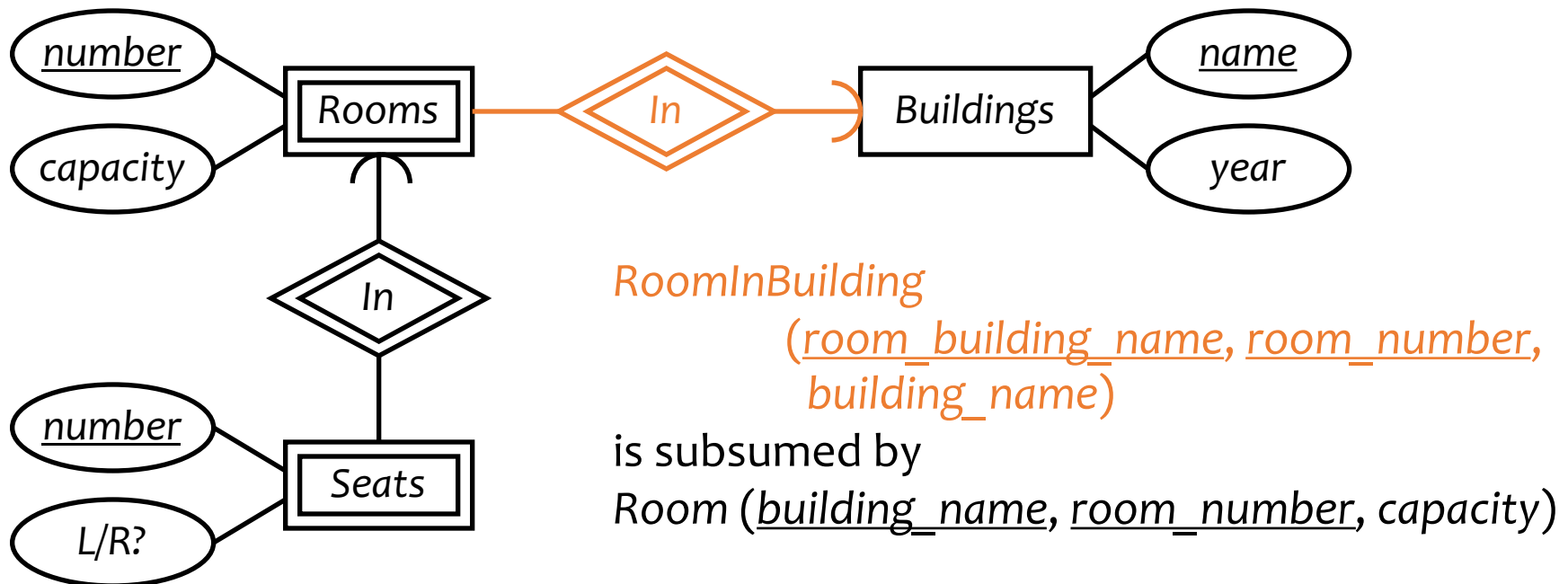

Translating subclasses & ISA: approach 1

- **Entity-in-all-superclasses** approach (“E/R style”)
 - An entity is represented in the table for each subclass to which it belongs
 - A table includes only the attributes directly attached to the corresponding entity set, plus the inherited key

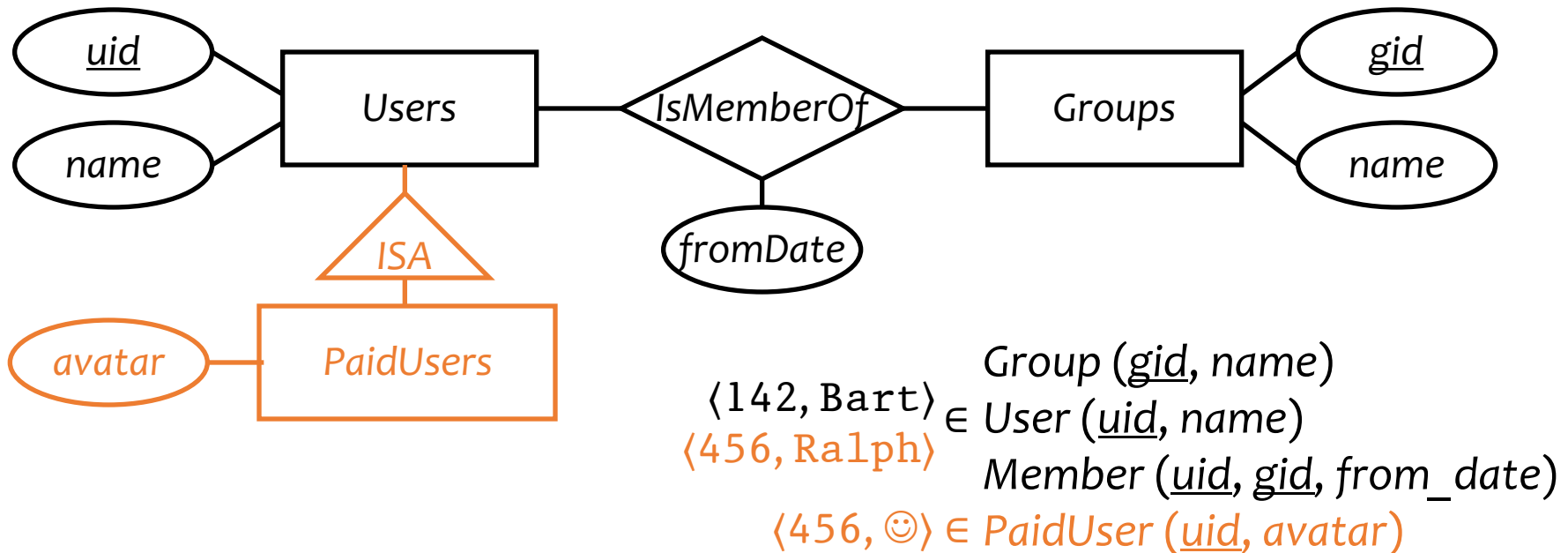

Translating subclasses & ISA: approach 2

- **Entity-in-most-specific-class** approach (“OO style”)
 - An entity is only represented in one table (the most specific entity set to which the entity belongs)
 - A table includes the attributes attached to the corresponding entity set, plus all inherited attributes

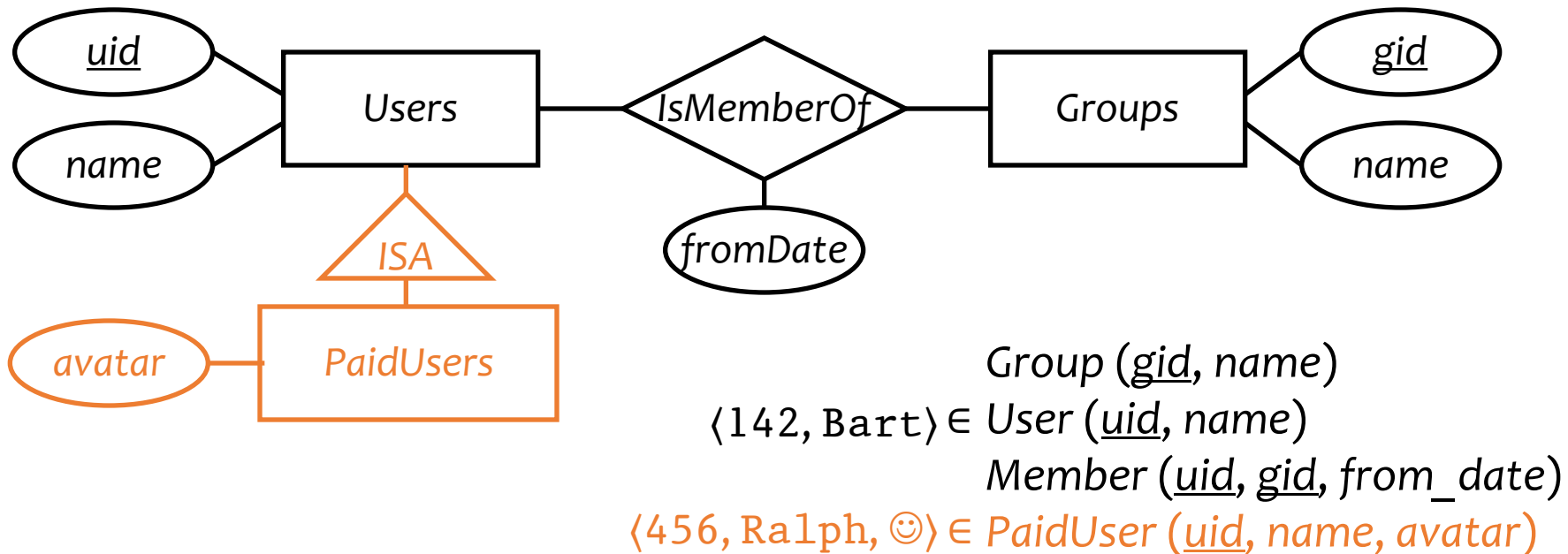

Translating subclasses & ISA: approach 3

- **All-entities-in-one-table** approach (“**NULL style**”)
 - One relation for the root entity set, with all attributes found in the network of subclasses (plus a “type” attribute when needed)
 - Use a special NULL value in columns that are not relevant for a particular entity

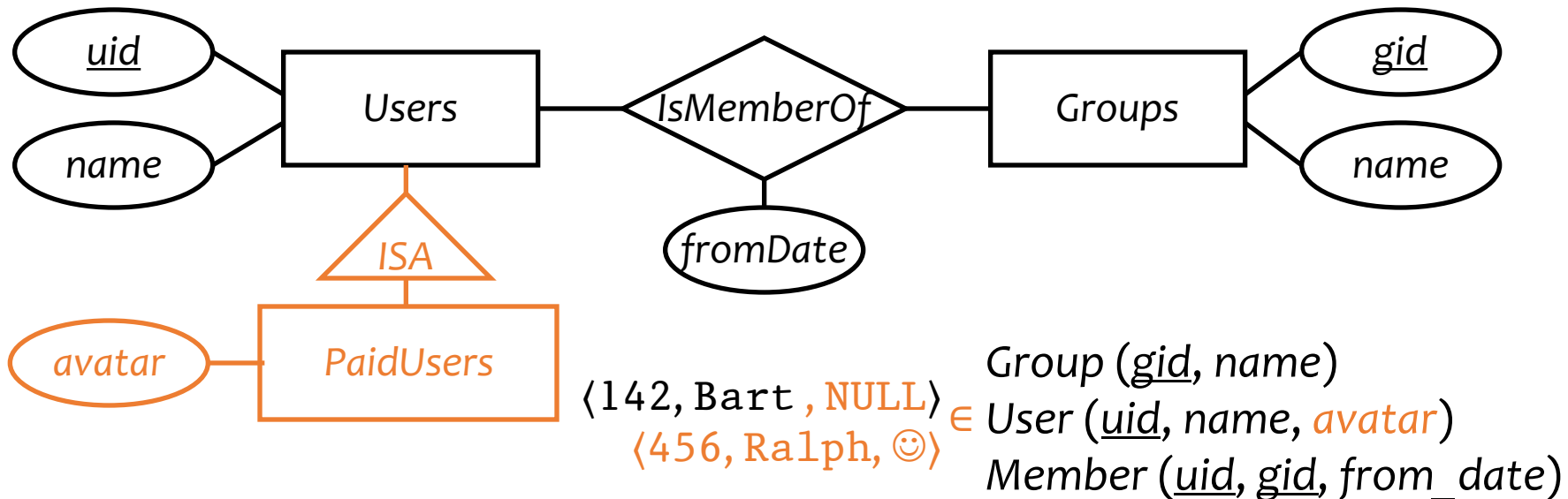

Comparison of three approaches

- Entity-in-all-superclasses
 - *User* (*uid*, *name*), *PaidUser* (*uid*, *avatar*)
 - Pro: All users are found in one table
 - Con: Attributes of paid users are scattered in different tables
- Entity-in-most-specific-class
 - *User* (*uid*, *name*), *PaidUser* (*uid*, *name*, *avatar*)
 - Pro: All attributes of paid users are found in one table
 - Con: Users are scattered in different tables
- All-entities-in-one-table
 - *User* (*uid*, [*type*,]*name*, *avatar*)
 - Pro: Everything is in one table
 - Con: Lots of NULL's; complicated if class hierarchy is complex

A complete example

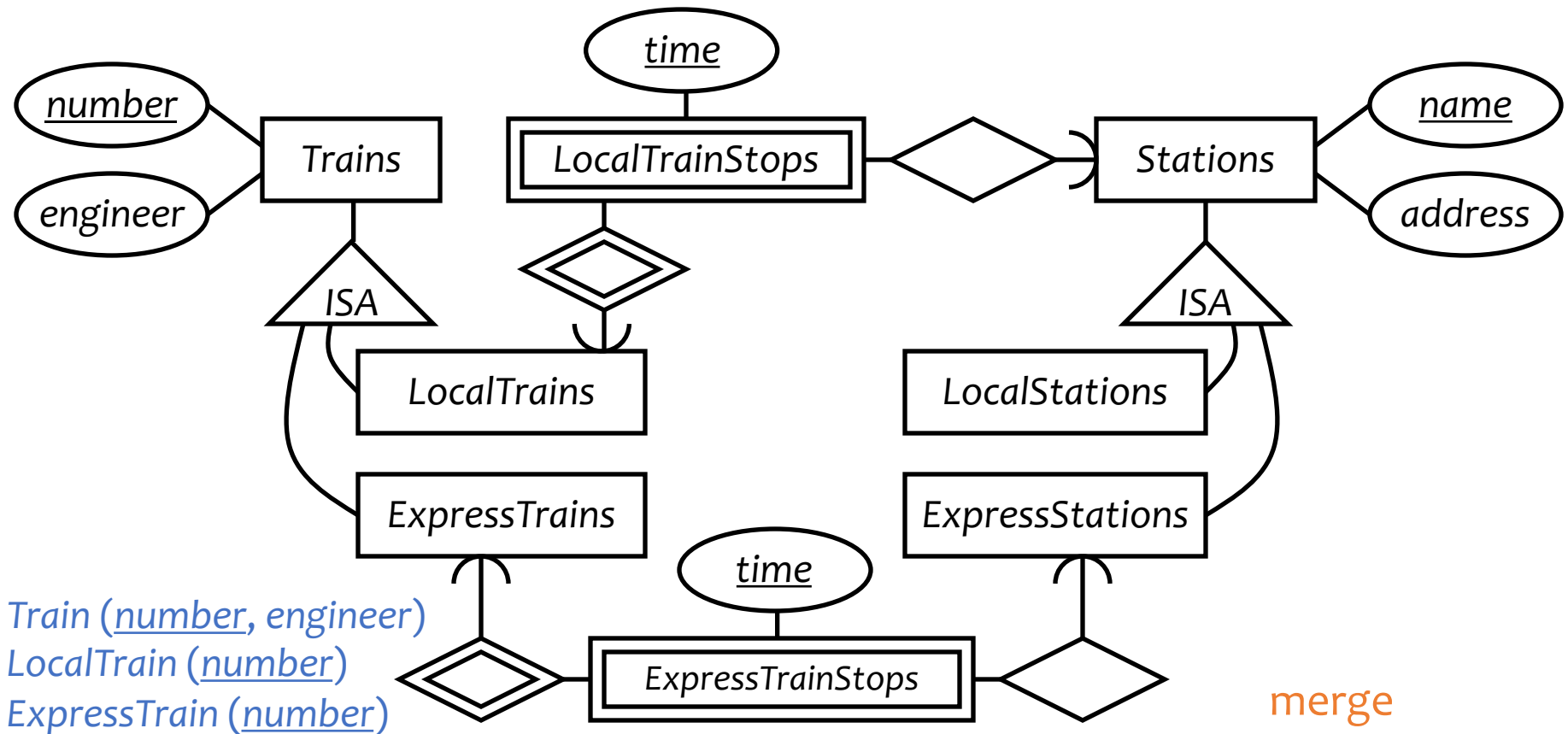

Train (number, engineer)
 LocalTrain (number)
 ExpressTrain (number)

Station (name, address)
 LocalStation (name)
 ExpressStation (name)

LocalTrainStop (local_train_number, time)

LocalTrainStopsAtStation (local_train_number, time, station_name)

ExpressTrainStop (express_train_number, time)

ExpressTrainStopsAtStation (express_train_number, time, express_station_name)

merge

merge

Simplifications and refinements

Train (number, engineer), *LocalTrain* (number), *ExpressTrain* (number)
Station (name, address), *LocalStation* (name), *ExpressStation* (name)
LocalTrainStop (local_train_number, station_name, time)
ExpressTrainStop (express_train_number, express_station_name, time)

- Eliminate *LocalTrain* table
 - Redundant: can be computed as

$$\pi_{number}(Train) - ExpressTrain$$
 - Slightly harder to check that *local_train_number* is indeed a local train number
- Eliminate *LocalStation* table
 - It can be computed as $\pi_{number}(Station) - ExpressStation$

An alternative design

Train (number, engineer, type)

Station (name, address, type)

TrainStop (train_number, station_name, time)

- Encode the type of train/station as a column rather than creating subclasses
- What about the following constraints?
 - Type must be either “local” or “express”
 - Express trains only stop at express stations
 - ☞ They can be expressed/declared explicitly as database constraints in SQL (as we will see later in course)
- Arguably a better design because it is simpler!

Design principles

- **KISS**
 - Keep It Simple, Stupid
- Avoid redundancy
 - Redundancy wastes space, complicates modifications, promotes inconsistency
- Capture essential constraints, but don't introduce unnecessary restrictions
- Use your common sense
 - Warning: mechanical translation procedures given in this lecture are no substitute for your own judgment

