

## Section: Finite Automata

### Deterministic Finite Acceptor (or Automata)

A DFA =  $(Q, \Sigma, \delta, q_0, F)$

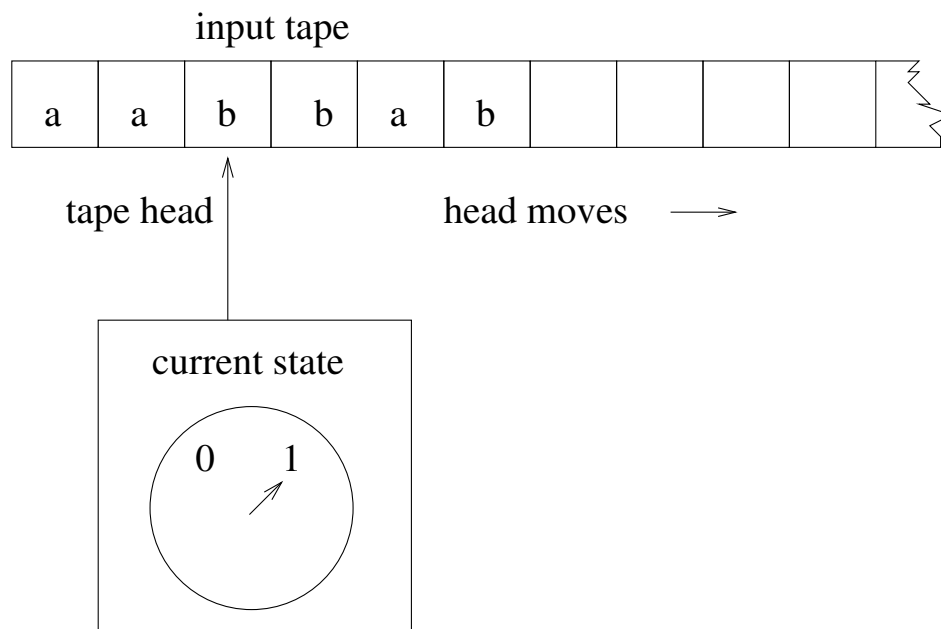

where

$Q$  is finite set of states

$\Sigma$  is tape (input) alphabet

$q_0$  is initial state

$F \subseteq Q$  is set of final states.

$\delta: Q \times \Sigma \rightarrow Q$

Example: DFA that accepts even binary numbers.

Transition Diagram:

$$M = (Q, \Sigma, \delta, q_0, F) =$$

Tabular Format

	0	1
q0		
q1		

Example of a move:  $\delta(q_0, 1) =$

## Algorithm for DFA:

Start in start state with input on tape

$q$  = current state

$s$  = current symbol on tape

while ( $s \neq \text{blank}$ ) do

$q = \delta(q,s)$

$s = \text{next symbol to the right on tape}$

if  $q \in F$  then accept

Example of a trace: 11010

# Pictorial Example of a trace for 100:

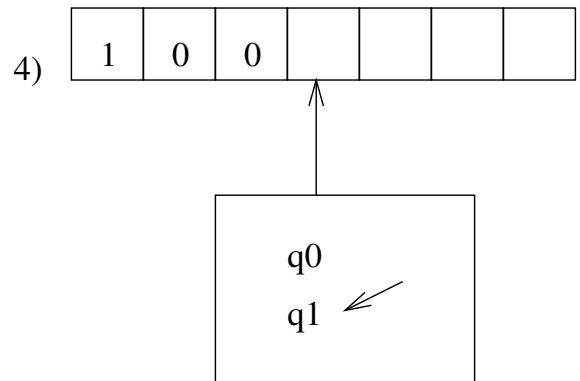
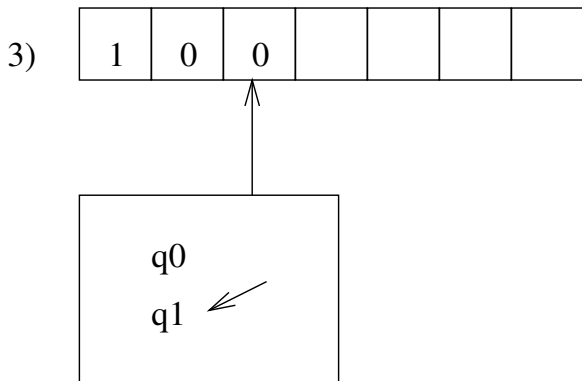
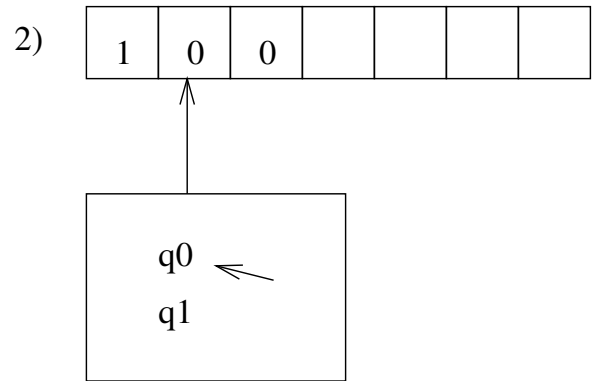
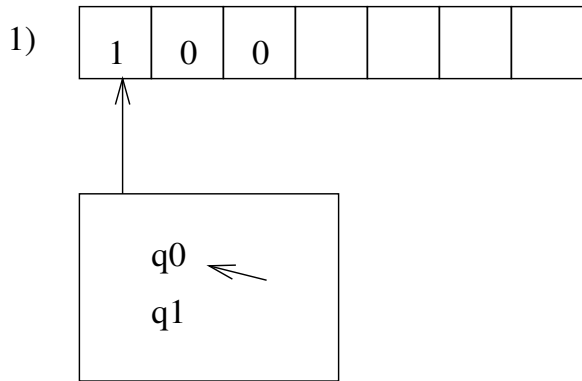

**Definition:**

$$\delta^*(q, \lambda) = q$$

$$\delta^*(q, wa) = \delta(\delta^*(q, w), a)$$

**Definition** The language accepted by a DFA  $M=(Q,\Sigma,\delta,q_0,F)$  is set of all strings on  $\Sigma$  accepted by  $M$ . Formally,  
 $L(M)=\{w \in \Sigma^* \mid \delta^*(q_0, w) \in F\}$

# Trap State

Example:  $L(M) =$

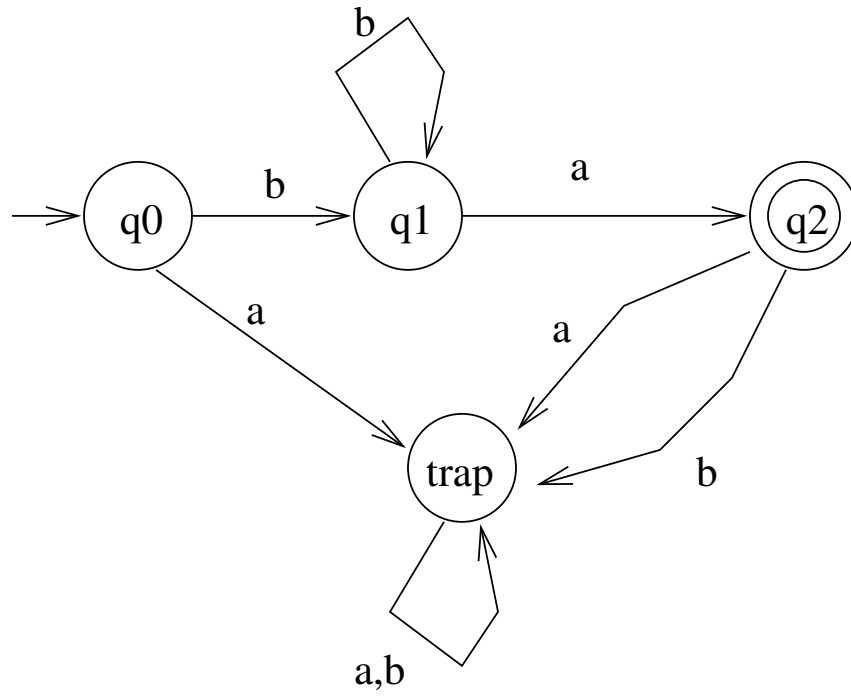

**Example:**

**$L = \{w \in \Sigma^* \mid w \text{ has an even number of a's and an even number of b's}\}$**

**Example: DFA that accepts even binary numbers that have an even number of 1's.**



**Definition** A language  $L$  is regular iff there exists DFA  $M$  s.t.  $L=L(M)$ .

## Chapter 2.2

### Nondeterministic Finite Automata (or Acceptor)

#### Definition

An NFA =  $(Q, \Sigma, \delta, q_0, F)$

where

$Q$  is finite set of states

$\Sigma$  is tape (input) alphabet

$q_0$  is initial state

$F \subseteq Q$  is set of final states.

$\delta: Q \times (\Sigma \cup \{\lambda\}) \rightarrow 2^Q$

# Example

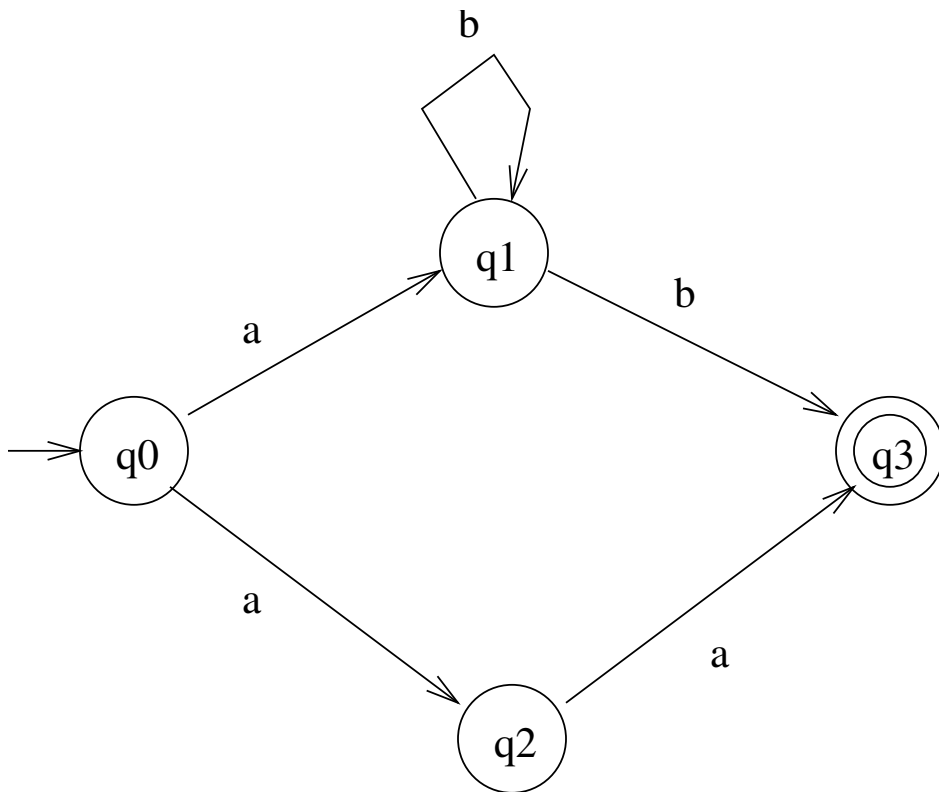

**Note:** In this example  $\delta(q_0, a) =$

**L=**

## Example

$$\mathbf{L} = \{(ab)^n \mid n > 0\} \cup \{a^n b \mid n > 0\}$$

**Definition**  $q_j \in \delta^*(q_i, w)$  if and only if there is a walk from  $q_i$  to  $q_j$  labeled  $w$ .

**Example** From previous example:

$$\delta^*(q_0, ab) =$$

$$\delta^*(q_0, aba) =$$

**Definition:** For an NFA  $M$ ,

$$L(M) = \{w \in \Sigma^* \mid \delta^*(q_0, w) \cap F \neq \emptyset\}$$

## 2.3 NFA vs. DFA: Which is more powerful?

Example:

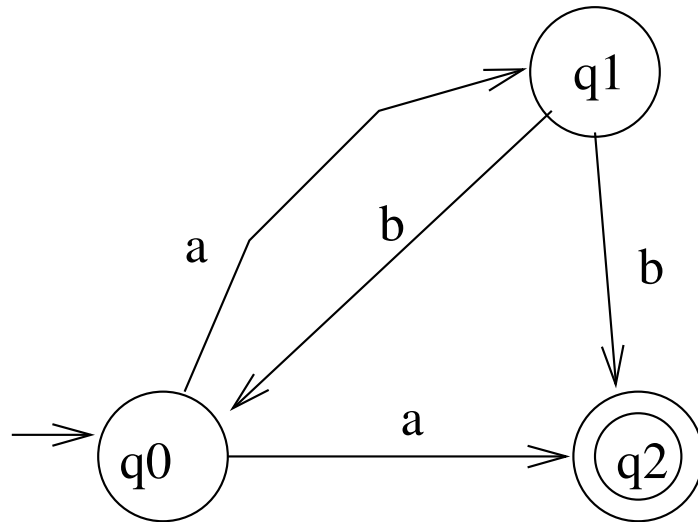

## Theorem Given an NFA

$M_N = (Q_N, \Sigma, \delta_N, q_0, F_N)$ , then there exists a DFA  $M_D = (Q_D, \Sigma, \delta_D, q_0, F_D)$  such that  $L(M_N) = L(M_D)$ .

**Proof:**

We need to define  $M_D$  based on  $M_N$ .

$Q_D =$

$F_D =$

$\delta_D :$

## Algorithm to construct $M_D$

1. start state is  $\{q_0\} \cup \text{closure}(q_0)$
2. While can add an edge
  - (a) Choose a state  $A = \{q_i, q_j, \dots, q_k\}$  with missing edge for  $a \in \Sigma$
  - (b) Compute  $B = \delta^*(q_i, a) \cup \delta^*(q_j, a) \cup \dots \cup \delta^*(q_k, a)$
  - (c) Add state  $B$  if it doesn't exist
  - (d) add edge from  $A$  to  $B$  with label  $a$
3. Identify final states
4. if  $\lambda \in L(M_N)$  then make the start state final.



**Example:**

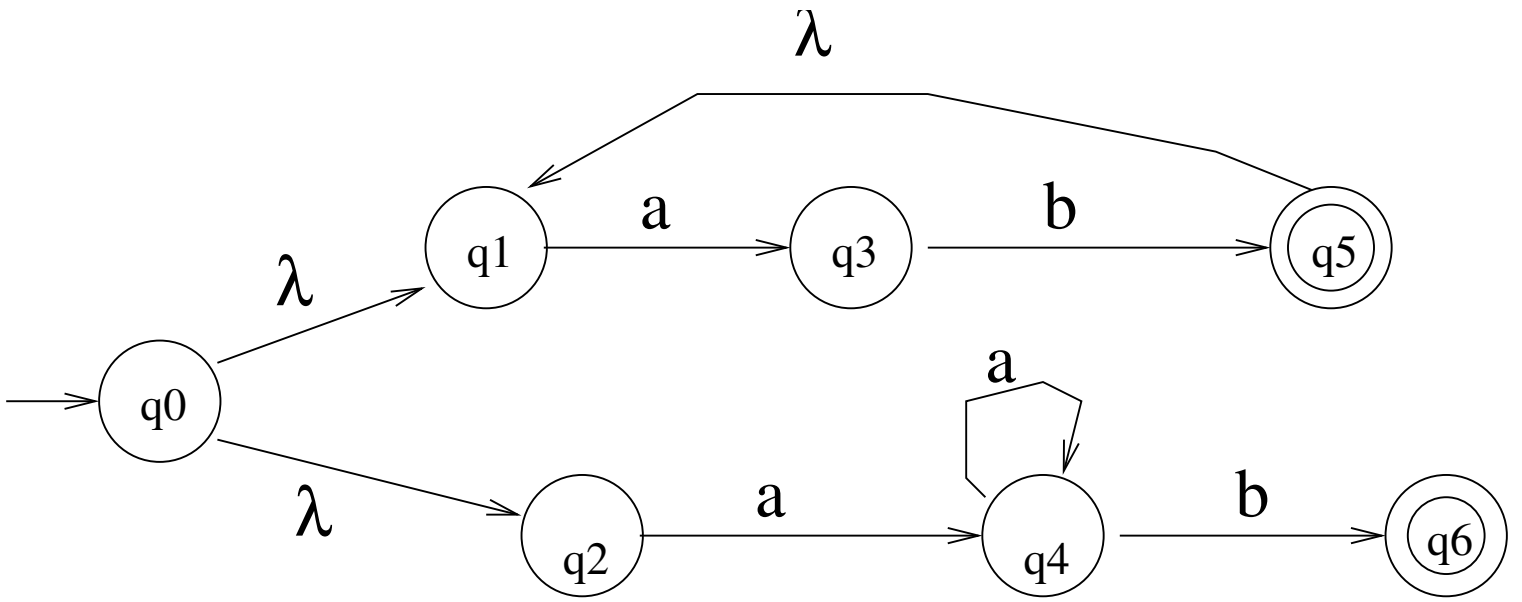

## Properties and Proving - Problem 1

Consider the property

Replace\_one\_a\_with\_b or  $R1awb$  for short. If  $L$  is a regular, prove  $R1awb(L)$  is regular.

The property  $R1awb$  applied to a language  $L$  replaces one  $a$  in each string with a  $b$ . If a string does not have an  $a$ , then the string is not in  $R1awb(L)$ .

**Example 1:** Consider  $L = \{aaab, bbaa\}$

$R1awb(L) =$

**Example 2:** Consider  $\Sigma = \{a, b\}$ ,  $L = \{w \in \Sigma^* \mid w \text{ has an even number of } a\text{'s and an even number of } b\text{'s}\}$

$R1awb(L) =$

**Proof:**

## Properties and Proving - Problem 2

Consider the property

Truncate\_all\_preceding\_b's or

TruncPreb for short. If  $L$  is a regular, prove  $\text{TruncPreb}(L)$  is regular.

The property TruncPreb applied to a language  $L$  removes all preceding b's in each string. If a string does not have an preceding b, then the string is the same in  $\text{TruncPreb}(L)$ .

**Example 1:** Consider  $L = \{aaab, bbaa\}$

$\text{TruncPreb}(L) =$

**Example 2:** Consider  $L =$

$\{(bba)^n \mid n > 0\}$

$\text{TruncPreb}(L) =$

**Proof:**

# Minimizing Number of states in DFA

Why?

Algorithm

- Identify states that are indistinguishable

These states form a new state

**Definition** Two states  $p$  and  $q$  are indistinguishable if for all  $w \in \Sigma^*$

$$\delta^*(q, w) \in F \Rightarrow \delta^*(p, w) \in F$$

$$\delta^*(p, w) \notin F \Rightarrow \delta^*(q, w) \notin F$$

**Definition** Two states  $p$  and  $q$  are distinguishable if  $\exists w \in \Sigma^*$  s.t.

$$\delta^*(q, w) \in F \Rightarrow \delta^*(p, w) \notin F \text{ OR}$$

$$\delta^*(q, w) \notin F \Rightarrow \delta^*(p, w) \in F$$

# Example:

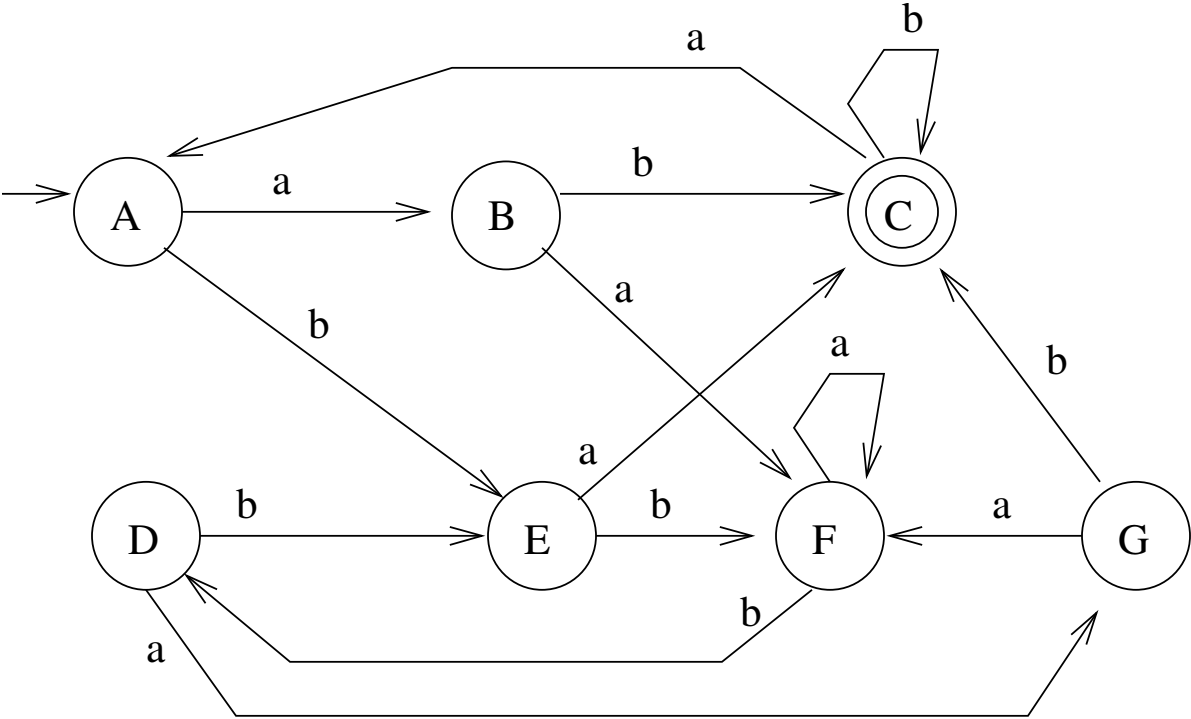

# Example:

